

PicoScope[®] 4444

See the difference: high-resolution differential USB oscilloscope



4 true differential inputs

Flexible 12- or 14-bit resolution

20 MHz bandwidth

Up to 400 MS/s sampling rate

256 MS capture memory

High common-mode rejection ratio

Balanced high-impedance inputs for a low circuit load

Intelligent probe interface

Measure differential signals with a single channel

Measure non-ground-referenced signals

Reject common-mode voltages in electronic and biomedical applications

Safely probe single and 3-phase voltages with 1000 V CAT III probes

Measure power drawn by mobile and IoT devices

Choice of accessories for sensitive low-level, general electronic and 1000 V CAT III applications

The PicoScope 4444: a new standard in differential measurement

With four true differential inputs, 12- to 14-bit resolution and wide differential and common-mode voltage ranges, the PicoScope 4444 and its accessories offer accurate and detailed measurement for a multitude of applications.

The two key accessories are the new PicoConnect™ differential voltage probes. We have used 9-pin D-type connectors to create a true differential probe interface. These Pico D9 connectors also allow the PicoScope software to automatically identify the probe and select the appropriate display settings.

The TA271 and TA299 adaptors allow you to use the PicoScope 4444 with traditional BNC-connected accessories.

1:1 differential probes

With most oscilloscopes, just connecting to the signal of interest can be very frustrating when one of the connection points has to be grounded. With the PicoConnect 441 1:1 differential voltage probe, the PicoScope 4444 high-resolution differential oscilloscope allows the freedom to connect to and visualize signals that are off-limits to a grounded-input oscilloscope. Connect directly to current-sensing resistors and differential signals, or across non-grounded components in a signal path.

The PicoConnect 441 probe does not attenuate your signal and is well suited to numerous electronics applications, as well as biomedical and other scientific research, as it allows high-speed high-resolution measurements on signals between ± 10 mV and ± 50 V in the presence of common-mode voltages and noise.

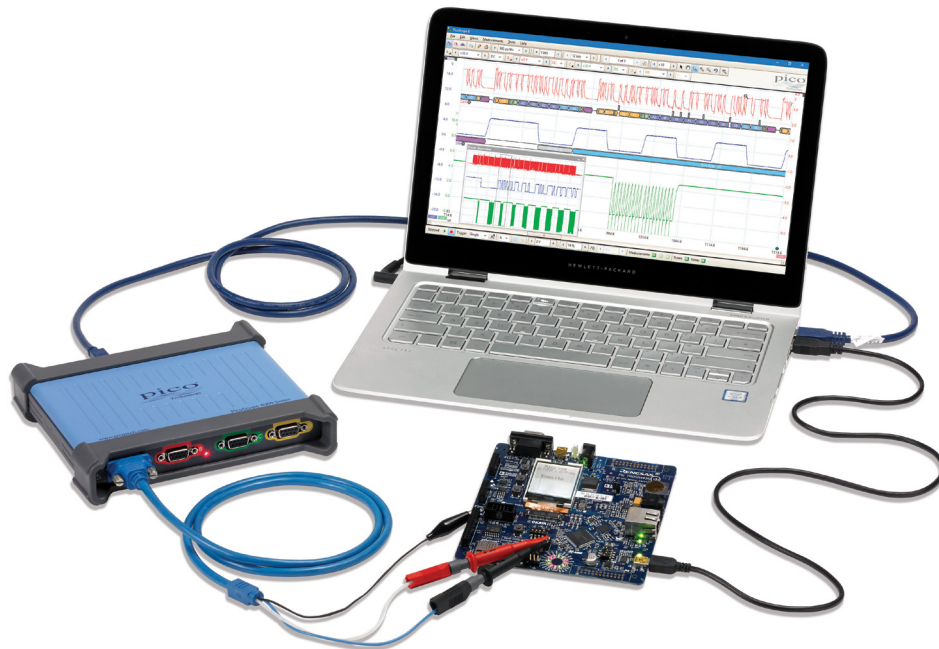

Embedded system design and test

1000 V CAT III differential probes

Testing and characterization of power supplies can present the oscilloscope user with many challenges, such as hazardous voltages (often floating without reference to ground), feedback circuitry with electrical isolation, and a wide range of signal levels. One wrong connection of a ground lead and sparks can fly! Using the PicoConnect 442 1000 V CAT III differential voltage probe with the PicoScope 4444, you can easily connect to and visualize the wide range of signals that need to be characterized.

The PicoConnect 442 probe has a 25:1 attenuation ratio and is suitable for testing in a range of applications, including distribution boards, circuit breakers, junction boxes, switches, fixed socket outlets and industrial equipment such as permanently connected stationary motors.

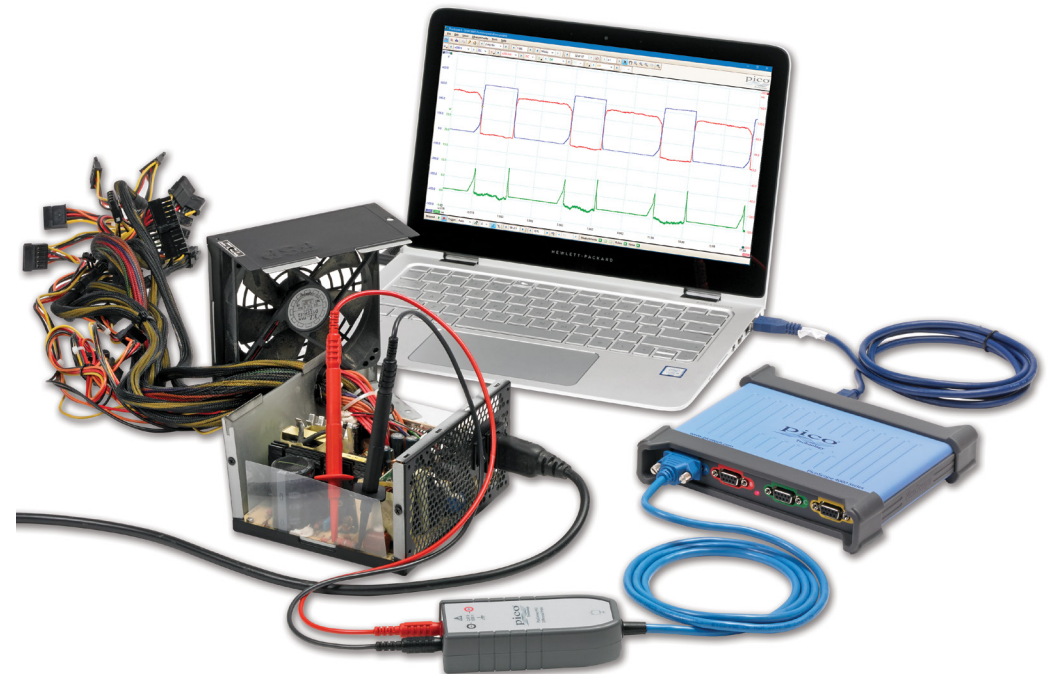

Power supply design and test

Why make differential measurements?

While you can make a wide variety of measurements with an ordinary ground-referenced scope, there are some circumstances where that just won't work.

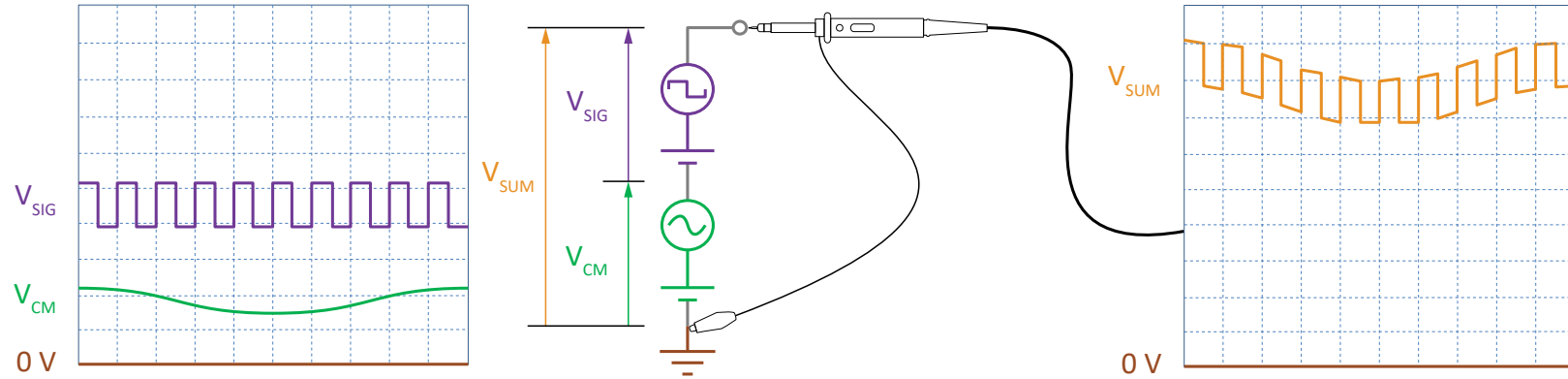

Common-mode voltages are unwanted signals that are applied equally to both measurement terminals in your probing system. The circuit above consists of a signal source (purple) with AC and DC components producing a total output of V_{SIG} , which we wish to measure. However, the circuit also contains an unwanted voltage source (green) that also has AC and DC components adding up to V_{CM} , a common-mode voltage. This situation is quite common, for example when probing high-side drivers in amplifiers and power supplies.

As the diagram above shows, probing this circuit with a single-ended scope results in a distorted waveform (V_{SUM}) on the display. We cannot simply connect the probe ground to the negative terminal of V_{SIG} , as that would short-circuit V_{CM} to ground through the oscilloscope, possibly causing a circuit malfunction or damage to the instrument. We need a measuring system that can safely detect V_{SIG} and ignore V_{CM} .

The solution, as shown below, is to connect a differential scope input across the positive and negative terminals of the signal source. The differential input does not measure V_{CM} , only V_{SIG} , so V_{SIG} is what you see on the oscilloscope display.

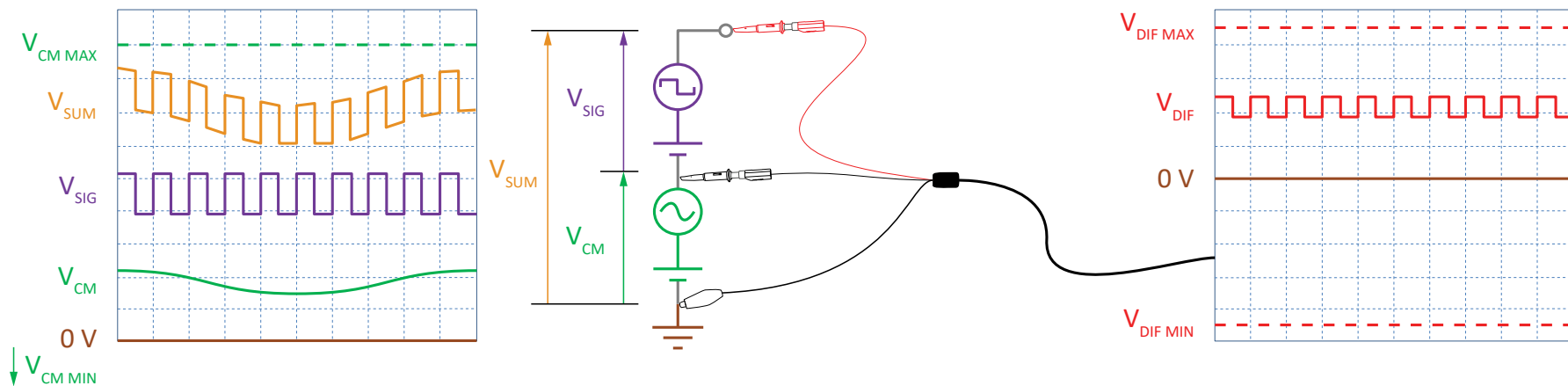

Differential scopes can measure the AC or DC voltage between two points connected to the positive and negative leads, when neither of the points is grounded. This enables them to take measurements where single-ended scopes can't, for example at voltages that are much higher than ground potential. The resulting measurements focus exclusively on the potential difference between the probes.

Why use the PicoScope 4444 differential oscilloscope?

There are, of course, plenty of differential probes available, all with similar inconveniences: bulky interface boxes, missing or flat batteries, snaking power leads... The PicoScope 4444 uses specially designed passive voltage probes that have smaller and lighter (or no) interface boxes. The PicoScope 4444 has high resolution and deep memory and lets you make multiple differential measurements at the same time, while never occupying more than one power socket. Its intelligent probe interface automatically configures the PicoScope display to your probes, so you don't have to.

True differential measurements in high resolution

The PicoScope 4444's four D9 inputs allow you to make true differential measurements. The maximum input range at full scale is ± 50 V (± 1000 V using the PicoConnect 442 1000 V CAT III probe), and the maximum common-mode range is also ± 50 V (also ± 1000 V with the PicoConnect 442 probe). You can set the scope to measure at resolutions of 12 or 14 bits, far better than the 8-bit resolution typical of many oscilloscopes. The deep capture memory (up to 256 million samples shared by the active channels) is another advantage, allowing you to carry out long captures without lowering the sampling rate.

The two images below show a sine wave with a sawtooth interference pattern, displayed on an 8-bit PicoScope 2208B (left) and a PicoScope 4444 in 12-bit mode (right). The PicoScope 2208B has greater bandwidth and a faster sampling rate than the PicoScope 4444, but fails to resolve the fine detail of the signal. The 12-bit resolution of the PicoScope 4444 offers 16 times as much vertical detail, and its deeper capture memory of 256 MS gives it greater horizontal resolution, too.

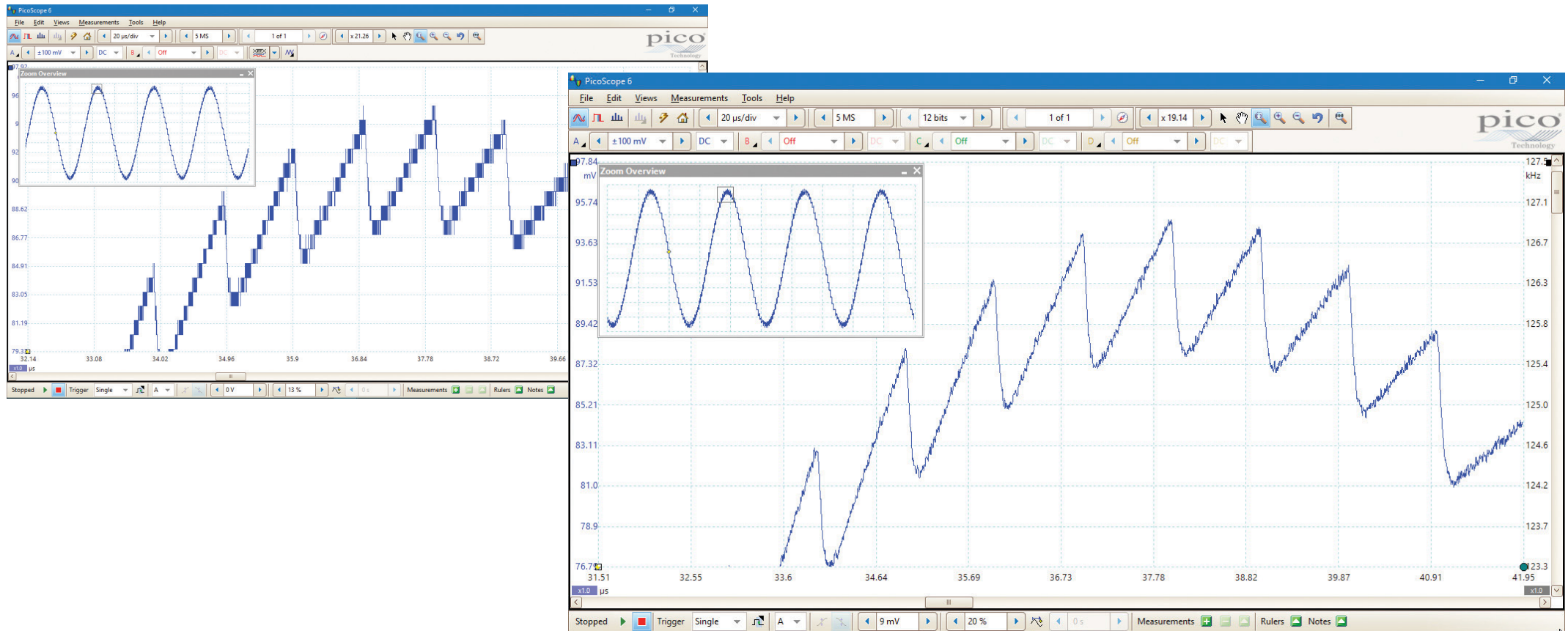

Deep memory

The PicoScope 4444 oscilloscope offers a large capture memory of 256 MS, allowing it to sustain high sampling rates across long timebases. Running at 12-bit resolution, it can sample at 400 MS/s all the way down to 50 ms/div giving a 500 ms total capture time.

Powerful tools are included to allow you to manage and examine all of this data. As well as functions such as mask limit testing and color persistence mode, the PicoScope 6 software enables you to zoom into your waveform by several million times. The Zoom Overview window allows you to easily control the size and location of the zoom area.

The image below shows how deep memory allows us to zoom in on an individual color burst in an NTSC signal, while preserving the detail of the signal.

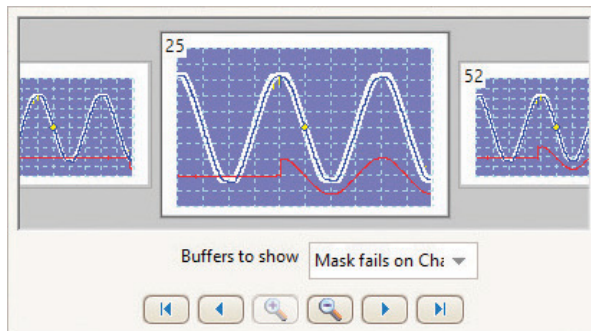
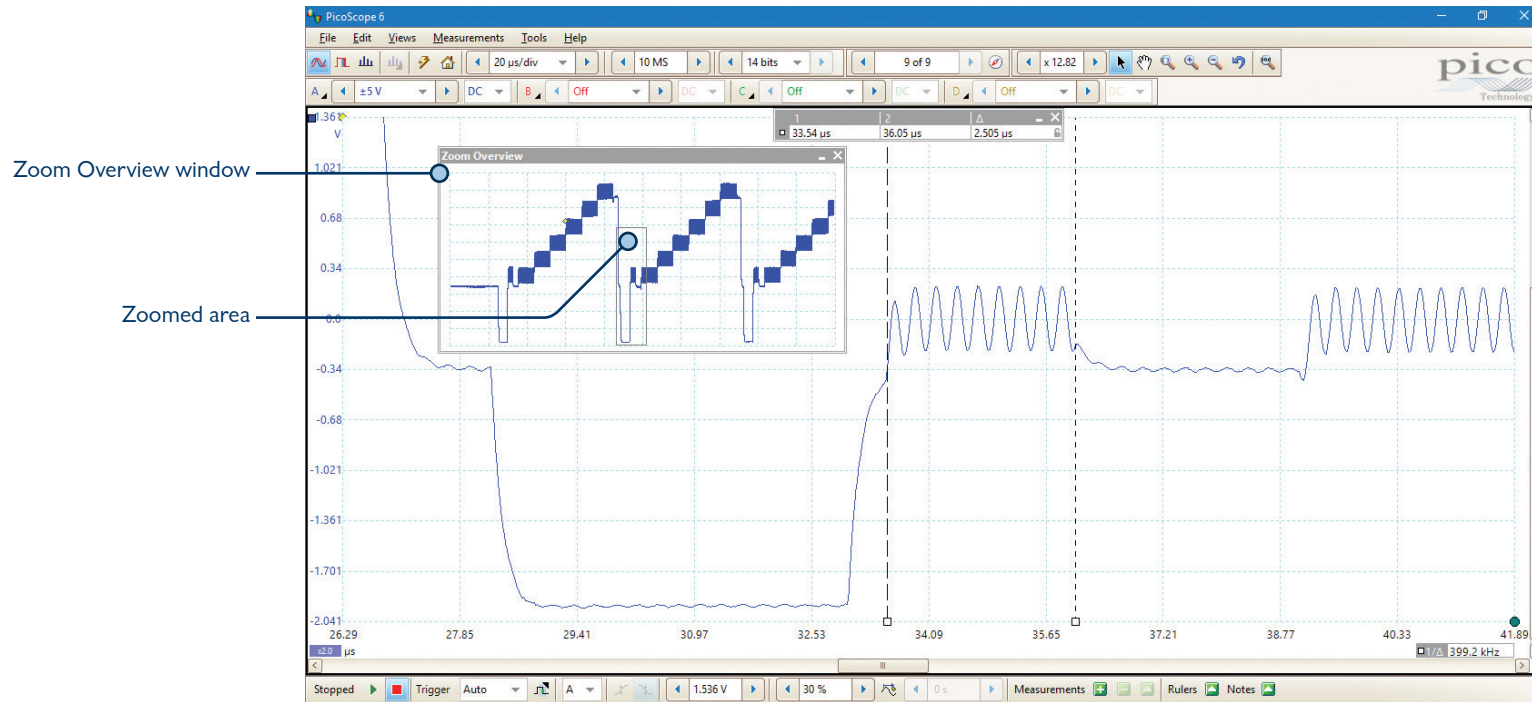

Up to 10 000 waveforms can be stored in the segmented waveform buffer. The Buffer Overview window then allows you to rewind and review the history of your waveform.

You can also use it to view mask limit test failures, making it far easier to spot infrequent glitches.

When the trace length is set to be shorter than the scope's memory, the PicoScope 4444 will automatically configure the memory as a circular buffer, recording recent waveforms for review. For example, if 1 million samples are captured, up to 250 waveforms will be stored in oscilloscope memory. Tools such as mask limit testing can then be used to scan through each waveform to identify anomalies.

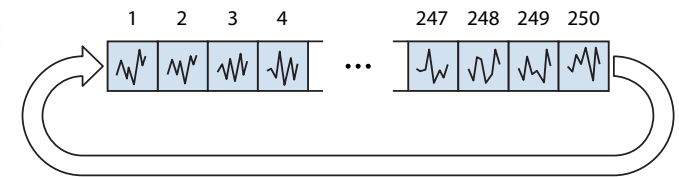

Unique intelligent probe interface

When you connect any Pico Technology probe with D9 connection to the PicoScope 4444, the PicoScope 6 software will detect, identify and, where necessary, power it. This means you spend less time setting up and don't have to worry about battery packs or power supplies. The software automatically sets up the display and controls to match your probe.

A notification appears in the bottom right corner of the PicoScope display whenever you connect or remove a probe.



Probe connected

Channel A - PicoConnect 441 1:1 probe



Probe removed

Channel A - PicoConnect 441 1:1 probe



Excellent value and convenience

The PicoScope 4444 differential oscilloscopes and their accessories are highly cost-effective, compact and convenient, especially compared to combining a traditional single-ended oscilloscope with the same number of differential probes.

Signal integrity

Careful front-end design and shielding reduces noise, crosstalk, and harmonic distortion. Years of oscilloscope design experience can be seen in improved bandwidth flatness, low distortion, and excellent pulse response. We are proud of the dynamic performance of our products, and publish their specifications in detail.

The result is simple: when you probe a circuit, you can trust in the waveform you see on the screen.

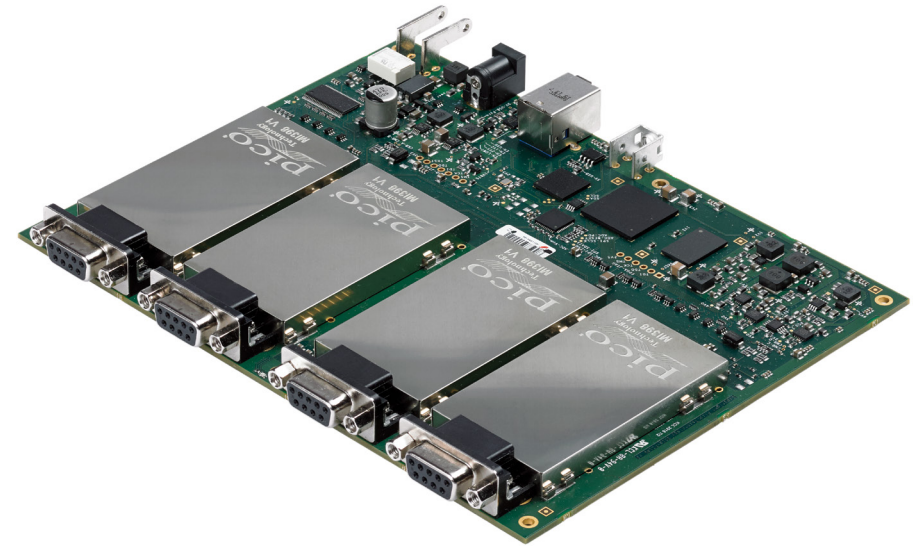

Accessories

The convenient preconfigured kits supplied by our distributors each include three differential voltage probes with Pico D9 connectors, and a single-ended D9-BNC adaptor. These and a range of other accessories are also available separately. See the table at the back of this document for prices and ordering information. Alternatively, you can devise your own configuration on our website, www.picotech.com.

Note that all accessories marked with the  symbol have Pico D9 connectors and can only be used with the PicoScope 4444. They have a unique intelligent probe interface, enabling the scope device to identify the probe and set up the display accordingly.

PicoConnect 441 probe: measure from millivolts to ± 50 V

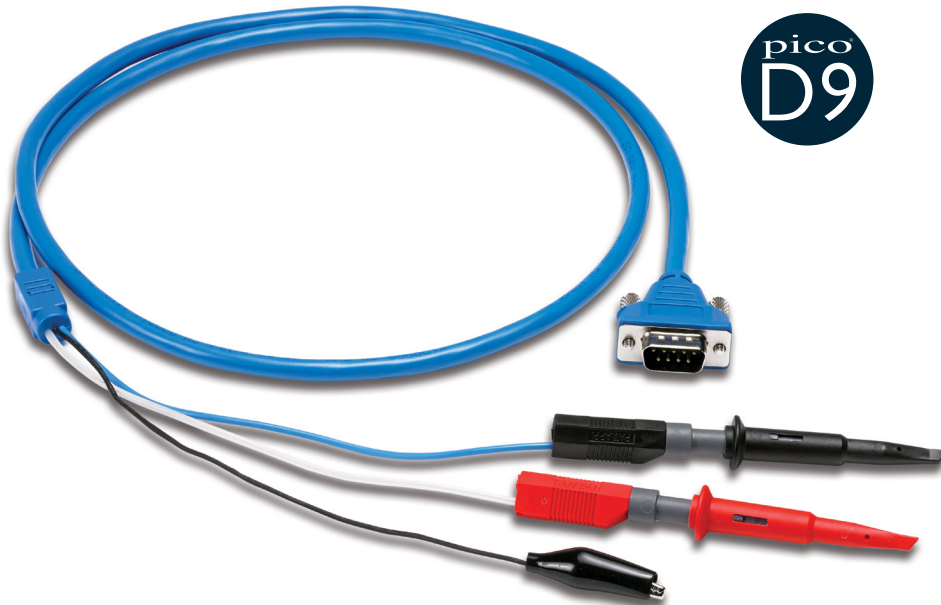

The PicoConnect 441 is a general-purpose passive differential probe with no attenuation and 20 MHz bandwidth, precisely measuring voltages on ranges from ± 10 mV to ± 50 V. The probe is fitted with a ground reference clip, as well as the usual positive and negative leads, to eliminate unknown common mode voltage differences between the probe and the device under test (DUT). It uses unshrouded 4 mm banana leads, so is compatible with a wide range of test probes: it comes with a pair of sprung hook probes.

This probe is ideal for anyone needing to make lower-amplitude, precision measurements in a wide range of applications. You can also use it to measure the differential outputs of differential serial buses such as CAN or RS-485.

PicoConnect 442 probe: 1000 V CAT III test leads

The PicoConnect 442 is a passive differential voltage measurement probe with 25:1 attenuation and 10 MHz bandwidth. It is rated for use up to 1000 V CAT III, and using this probe with the PicoScope 4444 is the most cost-effective way to make these measurements safely on multiple channels. With no need for a battery pack, the PicoConnect 442 is suitable for short- and longer-term voltage measurements.

The probe is double-insulated to eliminate the need for a safety ground. It is fitted with shrouded 4 mm banana leads and comes with a selection of suitable test probes.

Applications for this probe include testing the equipment listed for Overvoltage Category III under EN 61010-1:2010, such as measuring voltages on distribution boards, circuit breakers, and fixed socket outlets.



Current measurement probes

Two current probes are available with Pico D9 connections. The TA300 and TA301 both use the Hall effect to measure AC and DC currents. The intelligent probe interface means that the probes are powered directly by the PicoScope 4444, so you can use them to measure current for extended periods of time without worrying about flat batteries. It also means that when you connect either of these probes, the PicoScope 6 software automatically configures itself to display your signal.

TA300 current probe



The TA300 current probe is a 40 A AC/DC probe with 100 kHz bandwidth. It is a precision probe for smaller currents, rated for use up to 300 V CAT III on uninsulated conductors.

Overvoltage Category III covers the equipment making up the electrical installation within a building, including distribution boards, circuit breakers, junction boxes, switches, fixed socket outlets and industrial equipment such as permanently connected stationary motors.

TA301 current probe



The TA301 current probe is a switched-range 200/2000 A AC/DC probe with 20 kHz bandwidth, rated to 150 V CAT II on uninsulated conductors.

Overvoltage Category II is for equipment powered by wiring within the building, whether it is plugged in at a socket or permanently connected.

Flexible AC current probes

The TA325 and TA326 current probes use the Rogowski coil principle to measure AC currents up to 3000 A, without suffering from saturation. These probes have flexible sensor coils, enabling you to measure currents on conductors that clamp-type current probes just can't get to, while the long battery life means you can leave them connected for longer-term measurements.

Both of these probes are fitted with BNC connectors, so you will need to use TA271 single-ended D9-BNC adaptors to connect them to the PicoScope 4444.

TA325 flexible 3-phase current probe



The TA325 is a switched-range 30/300/3000 A AC RMS probe with 10 Hz to 20 kHz bandwidth, rated to 1000 V CAT III on uninsulated conductors. Suitable for measuring 3-phase AC current, it has three sensor coils and scope connection leads, color-coded to match Channels A, B and C in the PicoScope software. Typical battery life is 1000 hours.

You will need three TA271 D9-BNC adaptors in order to use this probe with the PicoScope 4444.

TA326 flexible current probe



The TA326 is a switched-range 30/300/3000 A AC RMS probe with 10 Hz to 20 kHz bandwidth, rated to 1000 V CAT III on uninsulated conductors. Typical battery life is 2000 hours.

You will need one TA271 D9-BNC adaptor in order to use this probe with the PicoScope 4444.



D9-BNC adaptors: use BNC accessories with the PicoScope 4444

The TA271 D9-BNC adaptor lets you use traditional differential voltage probes and current probes, and make single-ended measurements with a ground-referenced probe. It is also essential when using the TA325 and TA326 current probes.

The TA299 D9-dual BNC adaptor allows you to make differential measurements by connecting two ground-referenced passive probes or cable pairs to one scope input.



PicoScope 6 software

The PicoScope software display can be as basic or as detailed as you need. Begin with a single view of one channel, and then expand the display to include up to four live channels, plus math channels and reference waveforms. Display multiple scope and spectrum views in a configurable grid.

Tools menu: Set up custom probes, serial decoding, reference waveforms, mask tests, alarms and macros from the Tools menu.

Touchscreen controls: Handy buttons make fine adjustments easy on touchscreen devices.

Flexible resolution: Choose between 12- and 14-bit resolution.

Toolbars: Quickly access all the most frequently-used controls from toolbars, leaving the display clear for your waveforms.

Buffer Navigation toolbar: PicoScope can record up to 10 000 of your most recent waveforms. Click through the buffer to look for intermittent events, or use the Buffer Overview thumbnails.

Zooming and Scrolling toolbar: PicoScope makes it easy to zoom in on waveforms, with straightforward zoom-in, zoom-out and pan tools.

Channel options: Adjust settings specific to each channel here.

Auto Setup button: Let PicoScope configure the collection time and input range for a correctly scaled display.

Trigger marker: Drag the marker to adjust the trigger threshold and pre-trigger time.

Adjustable axes: Move the vertical axes up and down the display and vary their scale and offset. PicoScope can also rearrange the axes automatically.

Trigger toolbar: Quick access to the main controls, with advanced triggers in a pop-up window.

Automatic measurements: Add as many calculated time- and frequency-domain measurements as you need, along with statistical parameters showing their variability.

Spectrum view: View frequency-domain data alongside time-domain waveforms or in the dedicated spectrum mode.

Zoom Overview window: Click and drag for quick navigation and adjustment of zoomed views.

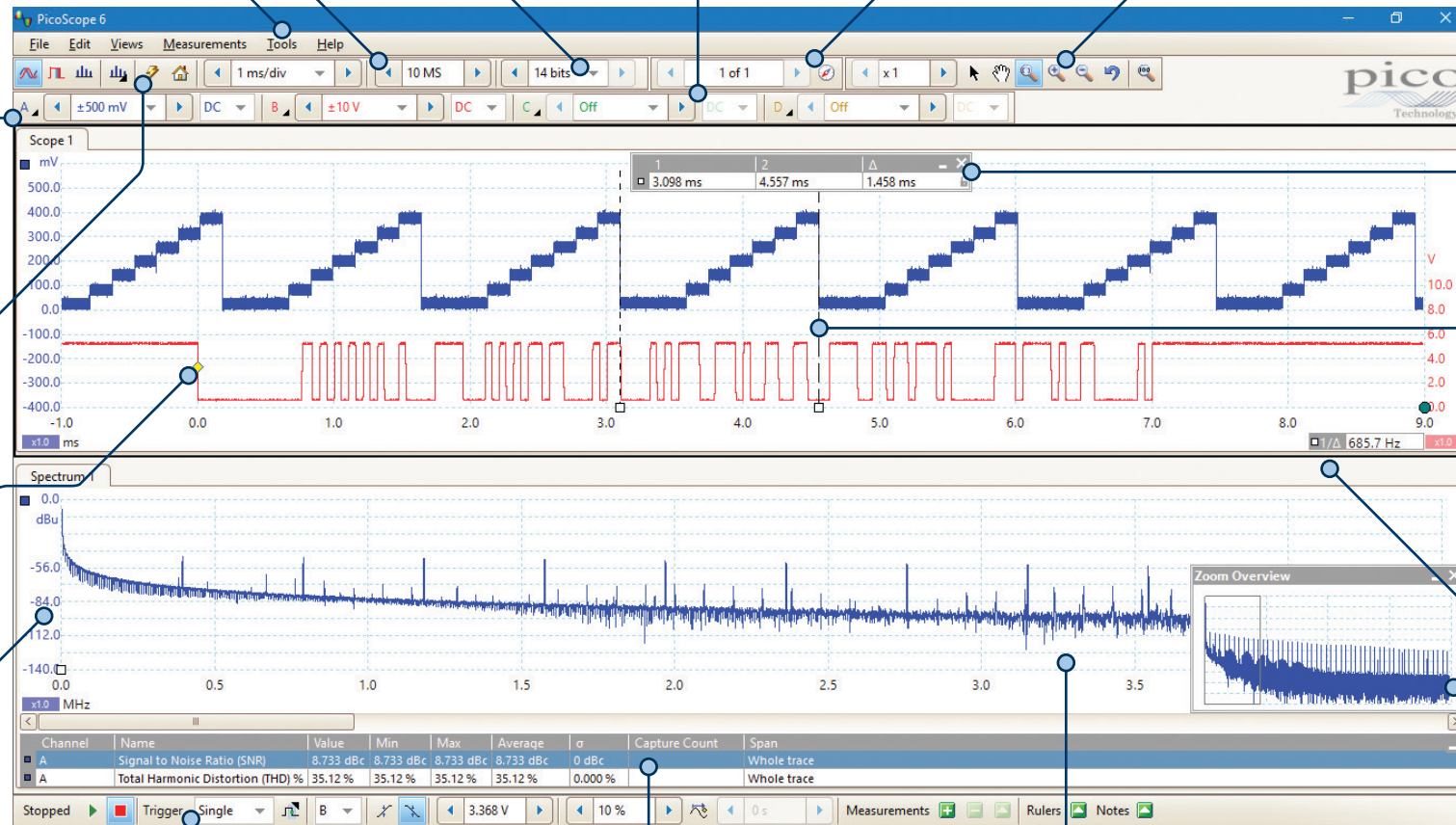

Ruler legend: Absolute and differential ruler measurements are listed here.

Rulers: Each axis has two rulers that you can drag across the screen to make quick measurements.

Views: Add new scope and spectrum views with automatic or custom layouts.

Advanced display

PicoScope 6 software lets you view your signals with exceptional detail and clarity. The majority of the display area is dedicated to the waveform, so you can see a huge amount of data at once.

- **Size**

The size of the display is limited only by the size of your monitor, so even on a laptop, the viewing area for a PicoScope USB oscilloscope is far larger than that of a typical benchtop scope. With a large waveform area available, you can select a customizable split-screen display to show different views of a signal at the same time. The software can even show multiple oscilloscope and spectrum analyzer traces at once.

- **Resolution**

The superior resolution offered by a PC monitor means that even with multiple views or complex signals, fine details are still visible.

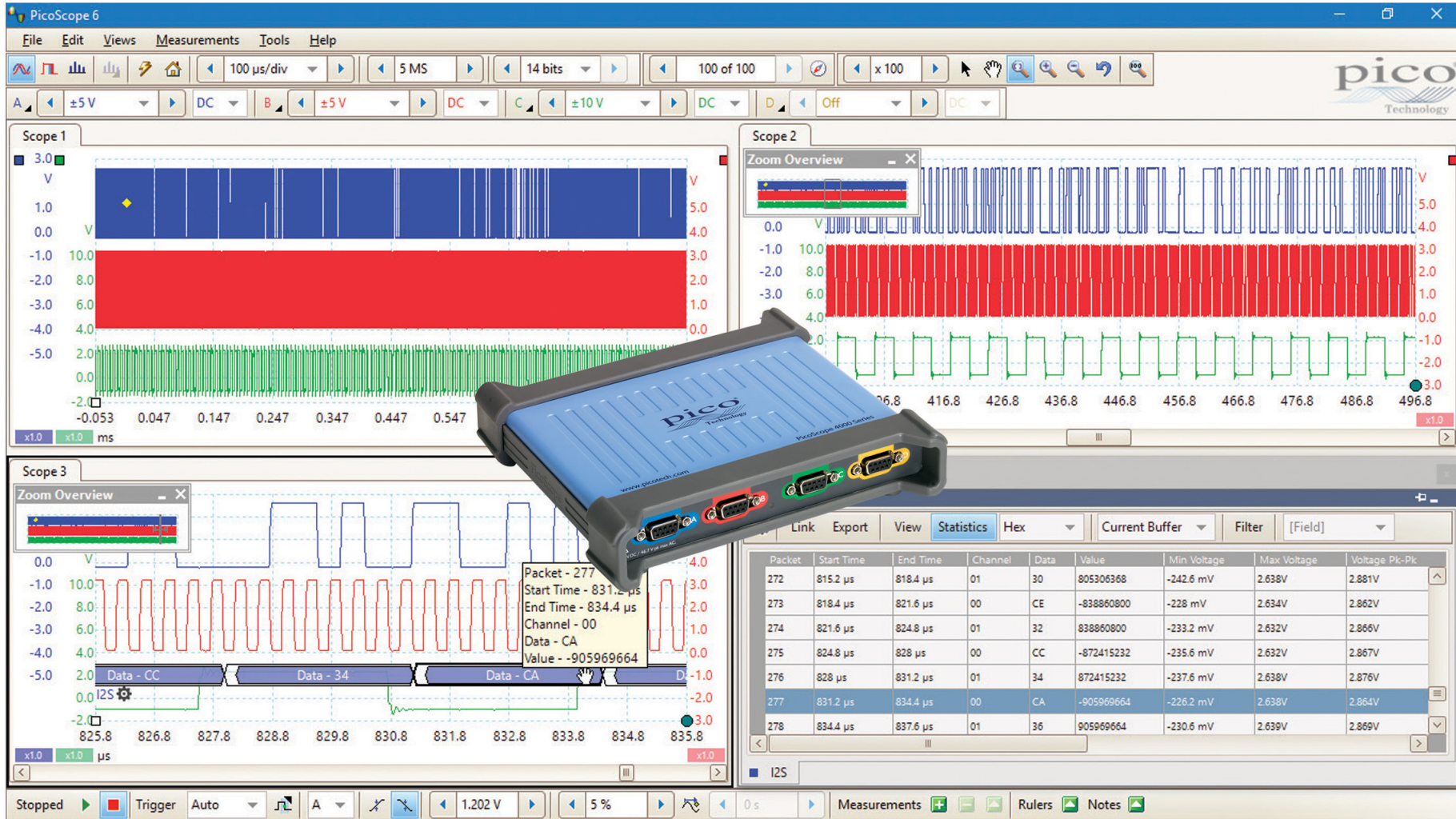

Spectrum analyzer

With a click of a button, you can display a spectrum plot of selected channels up to the bandwidth of the oscilloscope. A comprehensive range of settings gives you control over the number of spectrum bins and a choice of window functions and display modes.

You can display multiple spectrum views with different channel selections and zoom factors, and place these alongside time-domain views of the same data. A comprehensive set of automatic frequency-domain measurements can be added to the display, including THD, THD+N, SNR, SINAD and IMD.

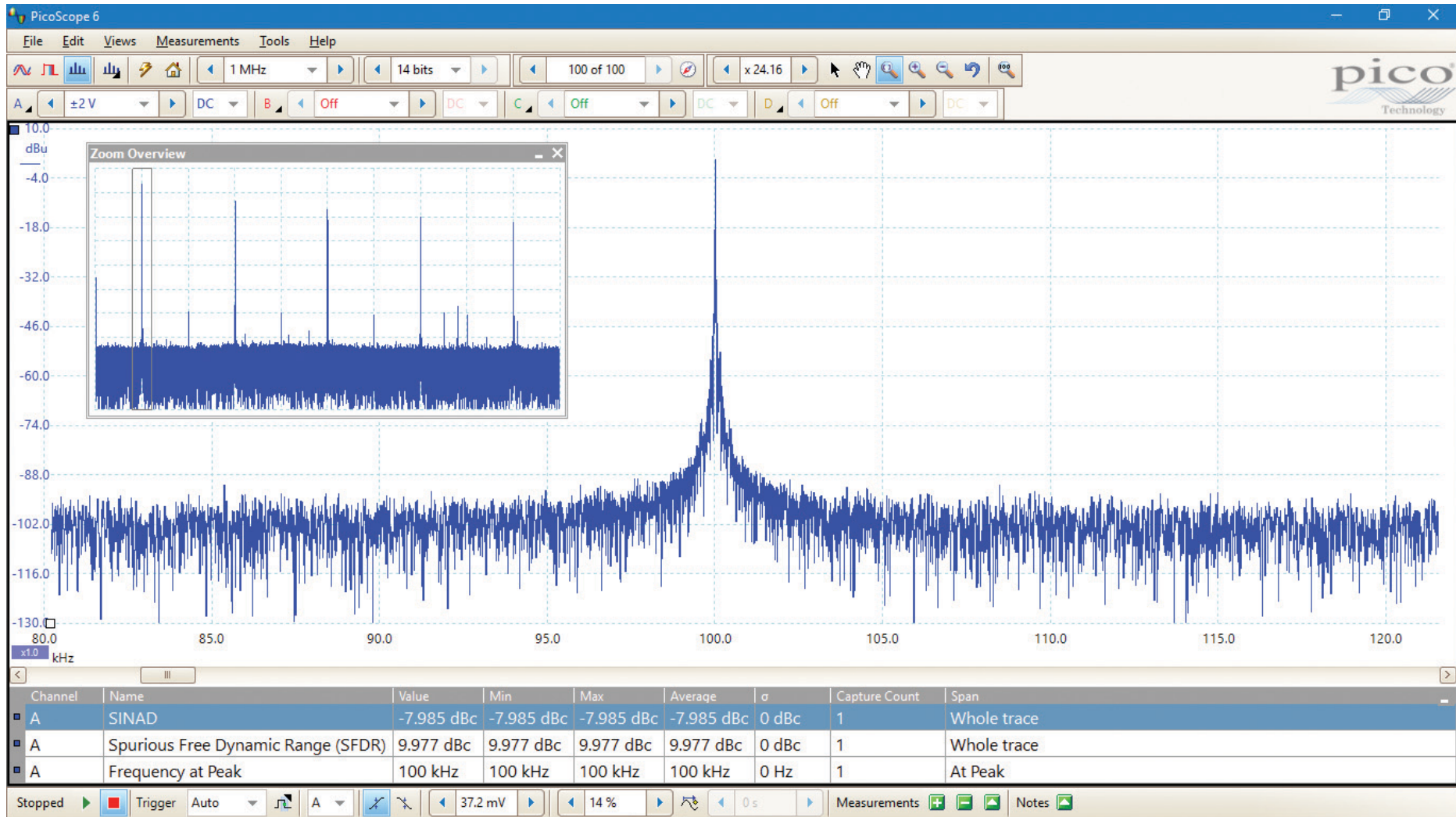

Serial decoding

All PicoScope oscilloscopes include serial decoding capability as standard. Display the decoded data in the format of your choice: as a **graph**, in a **table**, or both at once.

- **Graph** format shows the decoded data beneath the waveform on a common time axis, with error frames marked in red. You can zoom in on these frames to investigate noise or distortion. The data packets are broken down into their component fields, making it easier than ever to locate and identify problem signals, and each packet field is assigned a different color: in the CAN bus in the example below, the ID is colored orange, the DLC is light green, the data is indigo and the end of frame is purple, while in the LIN bus, the light gray start bit and the blue sync byte are visible.

- **Table** format shows a list of the decoded frames, including the data and all flags and identifiers. You can set up filtering conditions to display only the frames you are interested in or search for frames with specified properties.

It is also possible to link decoded numeric data to user-defined text strings, for ease of reading.

PicoScope also includes options to export the decoded data as an OpenDocument spreadsheet or a CSV file.

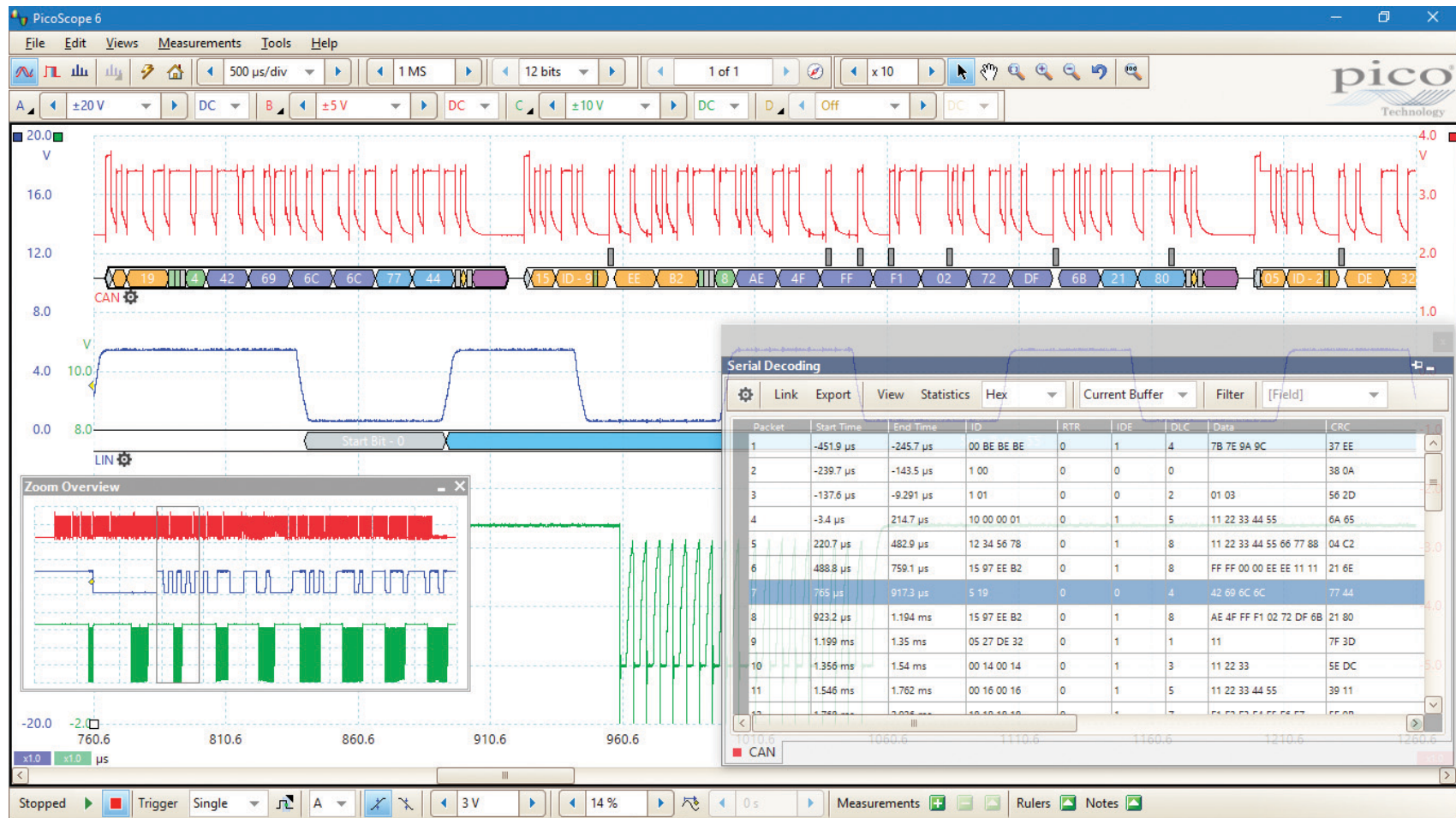

Advanced digital triggers

Since 1991, Pico Technology has been pioneering the use of digital triggering and precision hysteresis using the actual digitized data. Traditionally, digital oscilloscopes have used an analog trigger architecture based on comparators, which can cause time and amplitude errors that cannot always be calibrated out. Additionally, the use of comparators can often limit the trigger sensitivity at high bandwidths and can create a long trigger rearm delay.

PicoScopes broke new ground by being the first to use digital triggering. This method reduces errors and allows our oscilloscopes to trigger on the smallest signals, even at the full bandwidth. Trigger levels and hysteresis can be set with high precision and resolution.

Digital triggering also reduces rearm delay and this, combined with the segmented memory, allows the triggering and capture of events that happen in rapid sequence. At the fastest timebase you can use rapid triggering to collect 10 000 waveforms in under 12 ms, and still use mask limit testing to identify problem waveforms.

As well as simple edge triggers, a selection of time-based triggers are available for both digital and analog inputs, including:

- **Pulse-width trigger:** allows you to trigger on either high or low pulses which are shorter or longer than a specified time or which fall inside or outside a range of times.
- **Interval trigger:** measures the time between subsequent rising or falling edges. This allows you to trigger if a clock signal falls outside of an acceptable frequency range, for example.
- **Dropout trigger:** fires when a signal stops toggling for a defined interval of time, functioning as a watchdog timer.

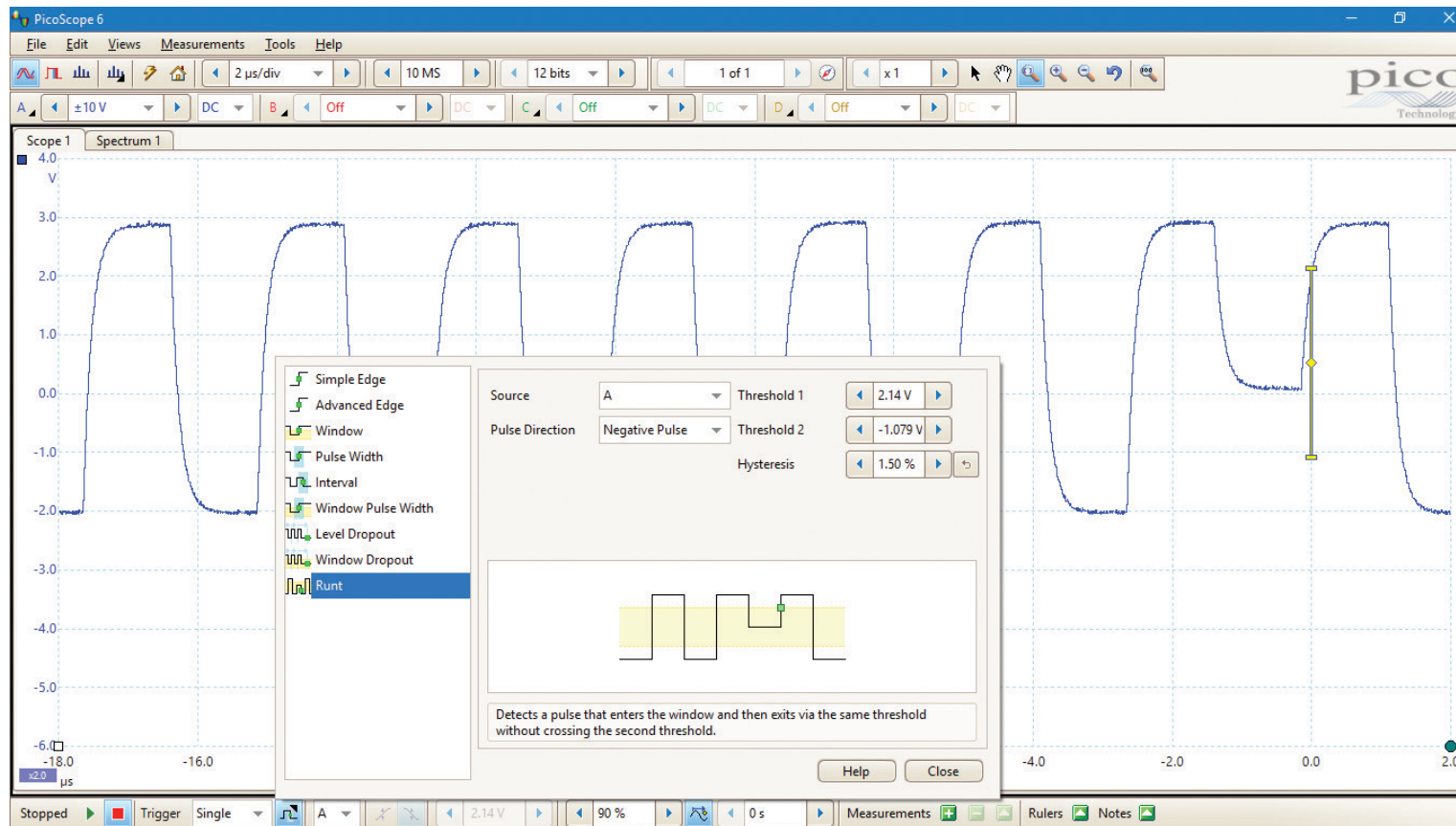

Mask limit testing

Mask limit testing allows you to compare live signals against known good signals, and is designed for production and debugging environments. Simply capture a known good signal, automatically generate a mask around it, and then attach the system under test. PicoScope will capture any intermittent glitches and can show a failure count and other statistics in the Measurements window, and you can set the waveform buffer navigator to show only mask fails, enabling you to find that glitch quickly. You can also easily edit, import and export masks, and you can run mask limit tests on multiple channels and in multiple viewports simultaneously.

The numerical and graphical mask editors can be used separately or in combination, allowing you to enter accurate mask specifications, modify existing masks, and import and export masks as files.

Mask limit testing works well when testing mains voltages (line power) with the PicoConnect 442 1000 V CAT III probe: probe the circuit and obtain a stable waveform, create a mask for it in PicoScope 6, and leave the scope running. The software will record any mask fails, which you can then view at your leisure.

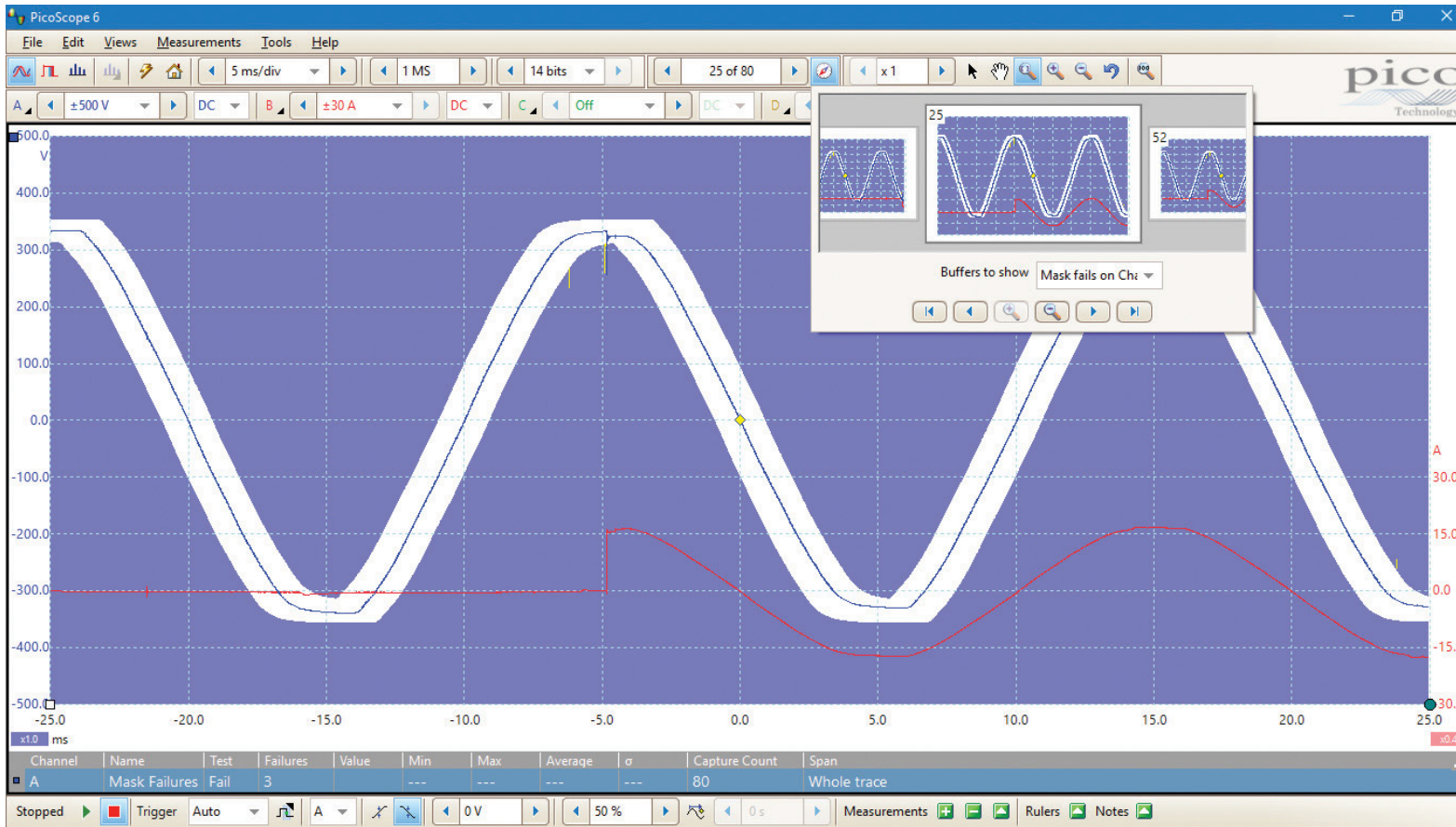

Using the built-in **Alarms** function, you can also set the PicoScope software to carry out a range of actions, including saving data, triggering the signal generator or beeping, in the event of a mask failure.

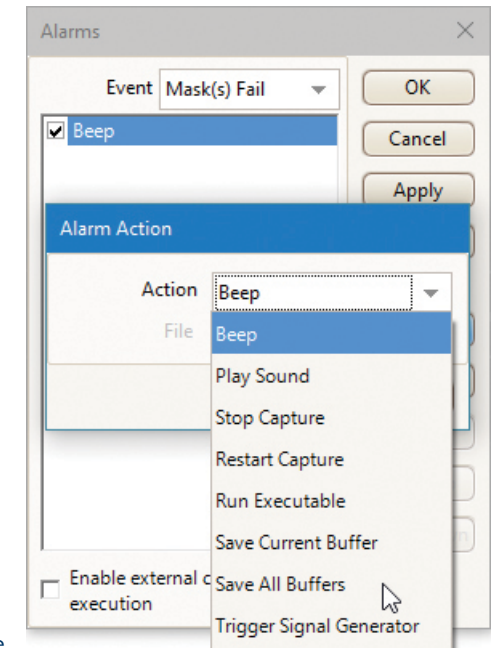

Plot frequency against time with PicoScope 6

All oscilloscopes can measure the frequency of a waveform, but often you need to know how that frequency changes over time, which is a difficult measurement to make.

The **freq** math function can do exactly this: in this example, it is being used to plot the frequency of the top waveform, revealing that it is exponentially modulated. Adding time and signal rulers allows measurement of the period and range of this modulation

You can also use the **duty** function to plot duty cycle in a similar way.

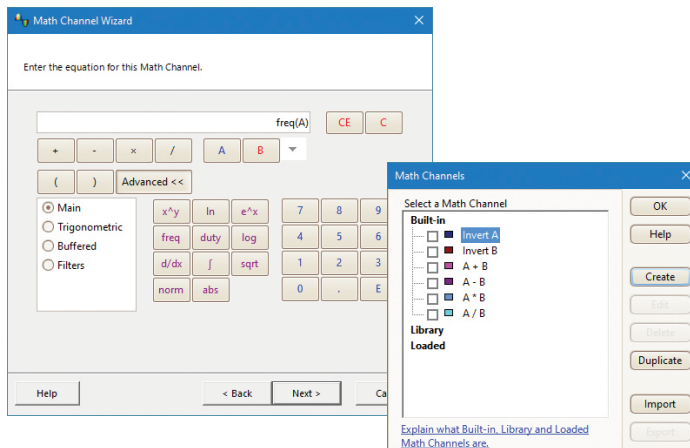
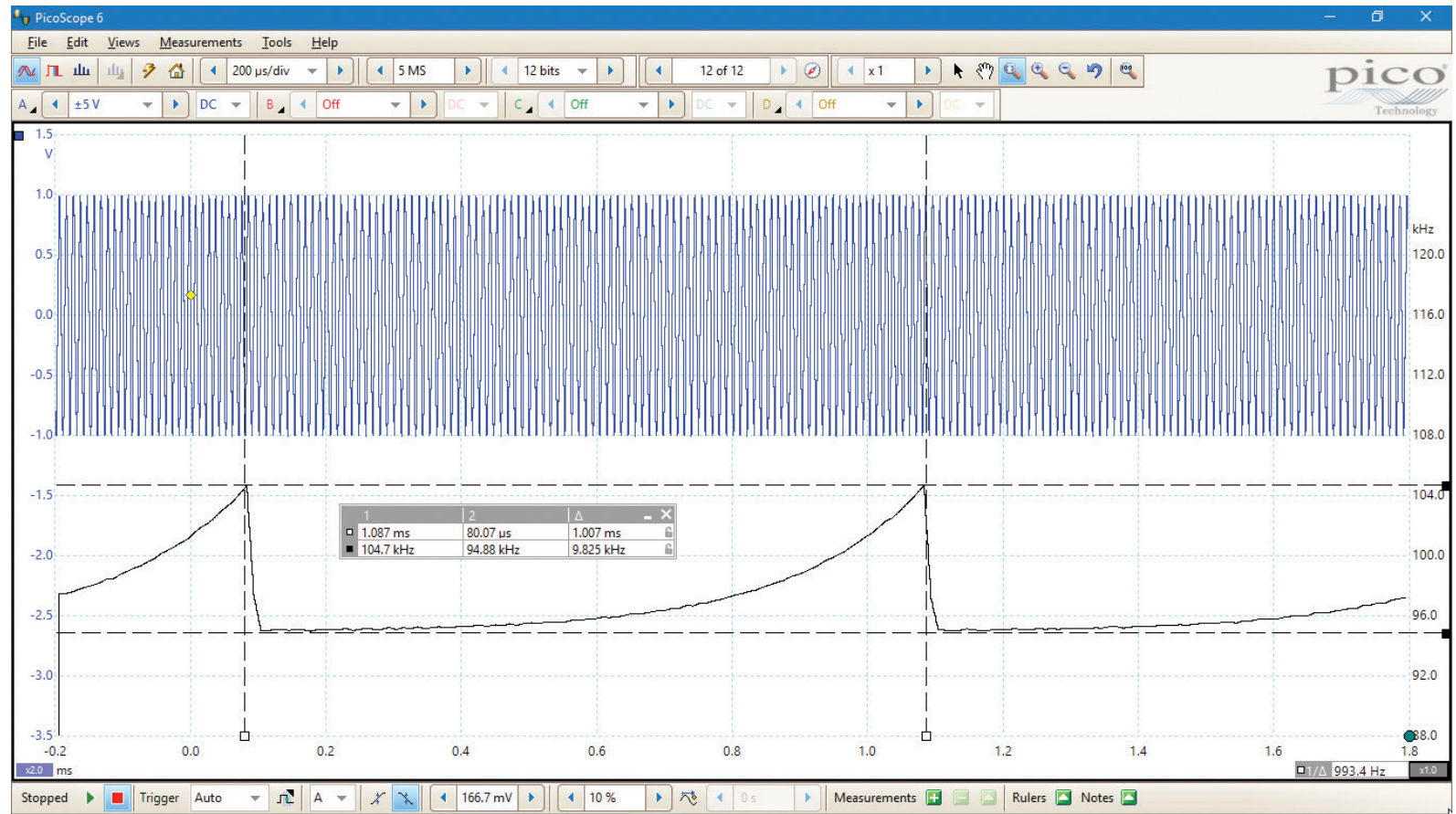

Math channels

With PicoScope 6 you can perform a variety of mathematical calculations on your input signals and reference waveforms.

Use the built-in list for simple functions such as add and invert, or open the wizard and create complex functions involving trigonometry, exponentials, logarithms, statistics, integrals and derivatives.

Rulers

PicoScope 6 contains a full set of rulers to help you make onscreen measurements. You can use just one ruler to make an absolute measurement, or a pair to make a delta measurement. All of them are easy to use - just use the colored ruler handles to drag the rulers into position.

- **Signal rulers** for every channel (including math channels and reference waveforms) help you to measure the signal amplitude on scope, spectrum and XY views.
- **Time and frequency rulers** let you measure time on a scope view and frequency on a spectrum view.
- **Phase rulers** help you measure the cyclic timing of a waveform on a scope view. This measurement is made relative to a time interval that you specify in degrees or percentage points.

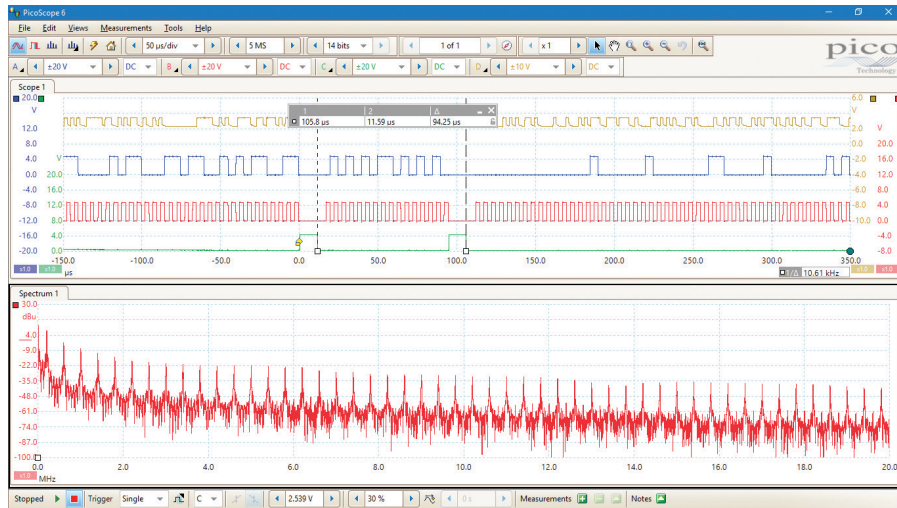

Automatic measurements

Manually measuring the waveform using rulers has its place, but for greater accuracy, PicoScope can calculate a range of measurements automatically, displaying them as a table of measurements for troubleshooting and analysis. Using the built-in measurement statistics you can see the average, standard deviation, maximum and minimum of each measurement as well as the live value.

You can add as many measurements as you need on each view, with a choice of 15 different measurements in scope mode and 11 in spectrum mode, including AC RMS, peak to peak and THD. For a full list of the available measurements, see **Automatic Measurements** in the Specifications table.

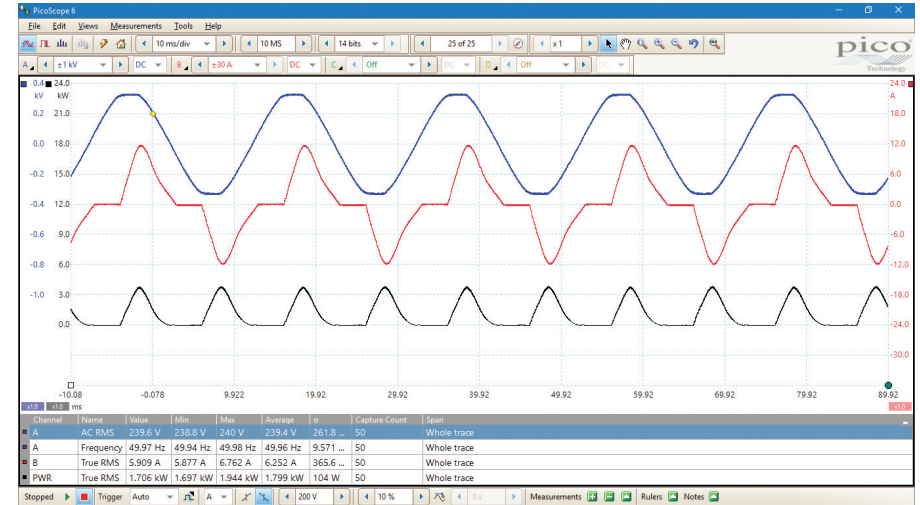

High-speed data acquisition and digitizing

The supplied drivers and the software development kit (SDK) allow you to write your own software and interface to popular third-party software packages such as National Instruments LabVIEW and MathWorks MATLAB.

The drivers support data streaming, a mode that captures gap-free continuous data over USB direct to the PC at rates of up to 100 MS/s, so you are not limited by the size of the scope's buffer memory. Sampling rates in streaming mode are subject to PC specifications and application loading.

Beta drivers are also available for use with Raspberry Pi, BeagleBone Black, and similar ARM-powered platforms, enabling you to control your PicoScope using these small, single-board Linux computers.

Specifications

VERTICAL

	OSCILLOSCOPE SPECIFICATIONS	SPECIFICATIONS WITH PICOCONNECT 442 1000 V CAT III PROBE
Input channels	4 channels	One differential pair per connected probe
Analog bandwidth (-3 dB)	20 MHz	10 MHz
Rise time (calculated)	17.5 ns	35 ns
Bandwidth limiter	100 kHz or 1 MHz (selectable)	100 kHz or 1 MHz (selectable)
Vertical resolution, 12-bit mode	12 bits on most input ranges 11 bits on ± 10 mV range	12 bits
Vertical resolution, 14-bit mode	14 bits on most input ranges 13 bits on ± 20 mV range 12 bits on ± 10 mV range	14 bits
Enhanced vertical resolution (PicoScope 6 software), 12-bit mode	Up to 16 bits on most input ranges Up to 15 bits on ± 10 mV range	Up to 16 bits
Enhanced vertical resolution (PicoScope 6 software), 14-bit mode	Up to 18 bits on most input ranges Up to 17 bits on ± 20 mV range Up to 16 bits on ± 10 mV range	Up to 18 bits
Input type	Differential 9-pin D-subminiature, female	Differential 2 x 4 mm sockets, shrouded
Input characteristics	1 M Ω $\pm 1\%$, in parallel with 17.5 pF ± 1 pF (each differential input to scope ground). <1 pF difference between ranges.	16.7 M Ω $\pm 1\%$, in parallel with 9.3 pF ± 1 pF (each differential input to scope ground)
Input coupling	AC or DC (selectable)	AC or DC (selectable)
Input sensitivity	2 mV/div to 10 V/div	± 0.5 V/div to ± 200 V/div
Input ranges (full scale)	± 10 mV, ± 20 mV, ± 50 mV, ± 100 mV, ± 200 mV, ± 500 mV, ± 1 V, ± 2 V, ± 5 V, ± 10 V, ± 20 V, ± 50 V	± 2.5 V, ± 5 V, ± 12.5 V, ± 25 V, ± 50 V, ± 125 V, ± 250 V, ± 500 V, ± 1000 V
Input common mode range	5 V on ± 10 mV to ± 500 mV ranges 50 V on ± 1 V to ± 50 V ranges	125 V on ± 2.5 V to ± 12.5 V ranges 1000 V on ± 25 V to ± 1000 V ranges
DC accuracy (DC to 10 kHz)	$\pm 1\%$ of full scale, ± 500 μ V	$\pm 3\%$ of full scale, ± 12.5 mV
Analog offset range	± 250 mV on ± 10 mV to ± 500 mV ranges ± 2.5 V on ± 1 V to ± 5 V ranges ± 25 V on ± 10 V to ± 50 V ranges	± 6.25 V on ± 2.5 V to ± 12.5 V ranges ± 62.5 V on ± 25 V to ± 125 V ranges ± 625 V on ± 250 V to ± 1000 V ranges
Analog offset accuracy	1% of offset setting in addition to basic DC accuracy	1% of offset setting in addition to basic DC accuracy
Overvoltage protection	± 100 V DC + AC peak (any differential input to ground) ± 100 V DC + AC peak (between differential inputs)	1000 V CAT III (any differential input to ground) 1000 V CAT III (between differential inputs)

HORIZONTAL

Maximum sampling rate (real time) 12-bit mode	1 channel: 400 MS/s 2 channels: 200 MS/s 3 or 4 channels: 100 MS/s
Maximum sampling rate (real time) 14-bit mode	1 channel: 50 MS/s 2 channels: 50 MS/s 3 or 4 channels: 50 MS/s
Maximum sampling rate (USB streaming)	10 MS/s
Capture memory (real time)	256 MS shared between active channels
Capture memory (USB streaming)	100 MS (shared between active channels)
Maximum duration of capture at fastest sampling rate (real time), 12-bit mode	500 ms
Maximum duration of capture at fastest sampling rate (real time), 14-bit mode	5 s
Maximum waveform buffer segments	10 000
Fastest real-time collection time, 12-bit mode	50 ns (5 ns/div)
Fastest real-time collection time, 14-bit mode	200 ns (20 ns/div)
Slowest real-time collection time	50 000 s (5000 s/div)
Collection time accuracy	±50 ppm (5 ppm/year aging)
Sample jitter	3 ps RMS typical
ADC sampling	Simultaneous sampling on all enabled channels

DYNAMIC PERFORMANCE (TYPICAL)

	OSCILLOSCOPE SPECIFICATIONS	SPECIFICATIONS WITH PICOCONNECT 442 1000 V CAT III PROBE
Crosstalk	2000:1 DC to 20 MHz	2000:1 DC to 10 MHz
Harmonic distortion at 100 kHz, 90% of full scale	< -70 dB on ±50 mV ranges and higher < -60 dB on ±10 mV and ±20 mV ranges	< -70 dB
SFDR	> 70 dB	> 70 dB
ADC ENOB, 12-bit mode	10.8 bits	10.8 bits
ADC ENOB, 14-bit mode	11.8 bits	11.8 bits
Noise	< 180 µV RMS on ±10 mV range	< 5 mV RMS on ±2.5 V range
Bandwidth flatness	(+0.1 dB, -3 dB) DC to full bandwidth	(+0.1 dB, -3 dB) DC to full bandwidth
Common mode rejection ratio	60 dB typical, DC to 1 MHz	60 dB typical, DC to 1 MHz

TRIGGERING

Source	Any channel
Trigger modes	None, auto, repeat, single, rapid
Trigger types	Edge, window, pulse width, window pulse width, dropout, window dropout, interval, runt pulse, logic
Trigger sensitivity	Digital triggering provides up to 1 LSB accuracy up to full bandwidth
Maximum pre-trigger capture	100% capture length
Maximum trigger time-delay	4 billion samples
Trigger rearm time	< 2 μ s on fastest timebase
Maximum trigger rate	10000 waveforms in a 12 ms burst

PROBE COMPENSATION PINS

Output level	4 V peak
Output impedance	610 Ω
Output waveforms	Square wave
Output frequency	1 kHz
Overvoltage protection	± 10 V

MATH CHANNELS

Functions	$-x$, $x+y$, $x-y$, $x*y$, x/y , x^y , sqrt, exp, ln, log, abs, norm, sign, sin, cos, tan, arcsin, arccos, arctan, sinh, cosh, tanh, freq, derivative, integral, min, max, average, peak, delay, duty, highpass, lowpass, bandpass, bandstop
Operands	A, B, C, D, T (time), reference waveforms, constants, pi

AUTOMATIC MEASUREMENTS

Scope mode	AC RMS, true RMS, frequency, cycle time, duty cycle, DC average, edge count, falling edge count, rising edge count, falling rate, rising rate, low pulse width, high pulse width, fall time, rise time, minimum, maximum, peak to peak
Spectrum mode	Frequency at peak, amplitude at peak, average amplitude at peak, total power, THD %, THD dB, THD+N, SFDR, SINAD, SNR, IMD
Statistics	Minimum, maximum, average and standard deviation

SERIAL DECODING

Protocols	1-Wire, ARINC 429, CAN, CAN FD, DCC, DMX512, Ethernet 10Base-T, FlexRay, I ² C, I ² S, LIN, PS/2, SENT, SPI, UART (RS-232 / RS-422 / RS-485), USB 1.0/1.1
-----------	---

MASK LIMIT TESTING

Statistics	Pass/fail, failure count, total count
------------	---------------------------------------

SDK/API DETAILS AND SPECIFICATIONS FOR USERS WRITING THEIR OWN SOFTWARE (see "HORIZONTAL" above for details when using PicoScope 6 software)

Supplied drivers	32- and 64-bit drivers for Windows 7, 8 and 10 Linux drivers Mac OS X drivers
Example code	C, C#, Excel VBA, VB.NET, LabVIEW, MATLAB
Maximum sampling rate (USB streaming)	50 MS/s
Capture memory (USB streaming)	Up to available PC memory
Segmented memory buffers	> 1 million

GENERAL SPECIFICATIONS

Connectivity	USB 3.0, USB 2.0
Device connector type	USB 3.0, Type B
Power requirements	USB port or external DC PSU, depending on connected accessories
Dimensions	190 x 170 x 40 mm including connectors
Weight	< 0.5 kg
Temperature range, operating	0 °C to 45 °C
Temperature range, operating, for quoted accuracy	15 °C to 30 °C
Temperature range, storage	-20 °C to 60 °C
Humidity range, operating	5% to 80% RH non-condensing
Humidity range, storage	5% to 95% RH non-condensing
Altitude	Up to 2000 m
Pollution degree	Pollution degree 2
Safety approvals	Designed to EN 61010-1:2010
EMC approvals	Tested to EN 61326-1:2013 and FCC Part 15 Subpart B
Environmental approvals	RoHS and WEEE compliant
Software	PicoScope 6, Linux drivers, Windows SDK and example programs
PC requirements	Windows 7, 8 or 10, 32-bit or 64-bit. Hardware requirements as operating system.

Ordering information

Oscilloscope kits

Product name	Description
PicoScope 4444 standard kit	High-resolution differential oscilloscope with three PicoConnect 441 1:1 passive differential voltage probes and one TA271 single-ended D9-BNC adaptor
PicoScope 4444 1000 V CAT III kit	High-resolution differential oscilloscope with three PicoConnect 442 1000 V CAT III passive differential voltage probes and one TA271 single-ended D9-BNC adaptor
PicoScope 4444 oscilloscope	High-resolution differential oscilloscope. Not available separately: must be purchased with at least one of the Pico D9 accessories listed below.

Accessories

Product name	Description	Connector
PicoConnect 441 probe	Passive differential 1:1 20 MHz voltage measurement probe. Supplied with detachable black and red sprung hook probe tips*.	Pico D9
PicoConnect 442 probe	1000 V CAT III, passive differential 25:1 10 MHz voltage measurement probe. Supplied with detachable shrouded black and red sprung hook probe tips*.	Pico D9
TA300 AC/DC current probe	40 A AC/DC, 300 V CAT III, 100 kHz current measurement probe	Pico D9
TA301 AC/DC current probe	200/2000 A AC/DC, 150 V CAT II, 20 kHz current measurement probe	Pico D9
TA325 flex current probe 3-phase	Flexible 3-phase switched-range 30/300/3000 A AC RMS, 1000 V CAT III, 10 Hz to 20 kHz current probe. Requires 3x TA271 D9-BNC adaptor (sold separately).	3x BNC
TA326 flex current probe	Flexible single-phase switched-range 30/300/3000 A AC RMS, 1000 V CAT III, 10 Hz to 20 kHz current probe. Requires 1x TA271 D9-BNC adaptor (sold separately).	BNC
TA271 D9-BNC adaptor	D9-BNC adaptor suitable for ground-referenced measurements using a single voltage or current probe with BNC connector	Pico D9
TA299 D9-dual BNC adaptor	D9-dual BNC adaptor suitable for differential measurements using two single-ended probes with BNC connectors	Pico D9
Carry case	Portable carry case to hold the PicoConnect 4444 and its accessories	N/A

Additional accessories are available for the PicoConnect 441 and 442 probes: see online for details.

Distribution via:

PSE- Priggen Special Electronic
Environmental Measuring Instruments

Sellen 102a * 48565 Steinfurt/GERMANY

Tel.: +49-2551/5770 * Fax: +49-2551/82422

E-mail: priggen@priggen.com

Internet: www.priggen.com